

Article number: 203502703350NI

Description: E+G Levelling sets GN 350.2-70-33-50-NI

Measures

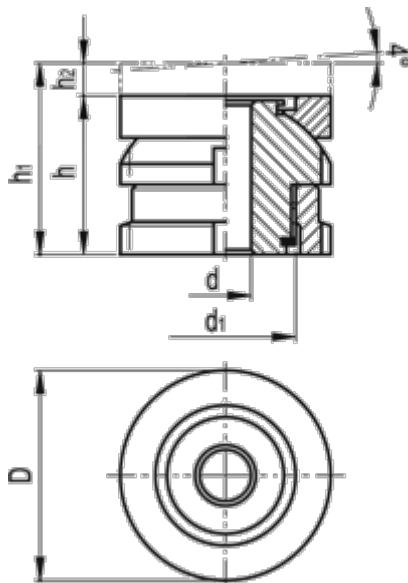

C-spanner DIN 1810 = A68-75

d = 33

D = 70

d_1 = M50x1.5

For screw = M30

h = 50

h_1 = 60

h_2 = 10

Max static load (kN) = 225

Static preload (kN) = 20.6

Weight (g) = 518